

HT-SB1
HT-WS1

Crystal Surround Air Track (Active Speaker System) user manual

imagine the possibilities

Thank you for purchasing this Samsung product.

To receive more complete service,
please register your product at

www.samsung.com/register



features

Active Speaker System

This unit features an Active Speaker System that provides high sound quality in a single slim unit.

This unit does not require any satellite loudspeakers or speaker cabling, which are normally associated with conventional surround sound systems.

Multi-function Remote Control

The supplied remote control can be used to control the TV connected to this unit.

The remote control has a TV hotkey that enables you to perform various operations with the simple press of a button.

You can adjust the volume, change the channel or customize the navigation menu of the TV using this Multi-function Remote Control.

Special Sound Field mode

You can select from three different sound field modes (NEWS, CINEMA and MUSIC) depending on the type of the source you want to enjoy.

Compatibility with various audio Technologies

This unit employs decoders compatible with Dolby Digital, DTS (Digital Theater Systems) and SFE (Sound Field Effect).

- **Dolby Digital**

This is the standard audio signal format used on DVDs and other purely digital media.

This surround technology delivers high-quality digital audio of up to 5.1 discrete channels to produce a directional and more realistic effect.

- **DTS (Digital Theater Systems)**

DTS provides a discrete 5.1 CH digital audio signal for both music and movie contents and uses less compression than Dolby Digital for richer sound.

- **SFE (Sound Field Effect) Using 32bit Audio Digital Signal Processing**

Provides more realistic surround sound with normal stereo audio sources.

Wireless Subwoofer (HT-WS1 only)

Samsung's wireless module does away with cables running between the main unit and the subwoofer. Instead, the subwoofer connects to a compact wireless module that communicates with the main unit.

WHAT'S INCLUDED

Check for the supplied accessories below.

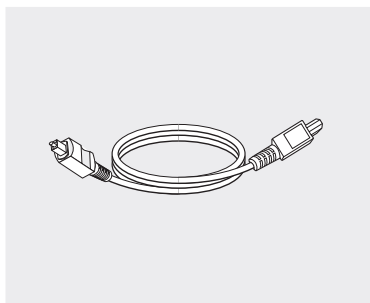

Optical Cable

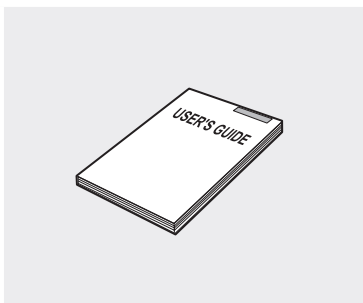

User's Manual



Remote Control / Batteries (AAA size)

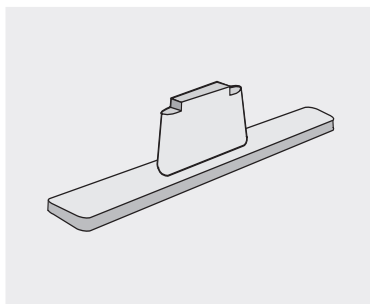

Cradle stand

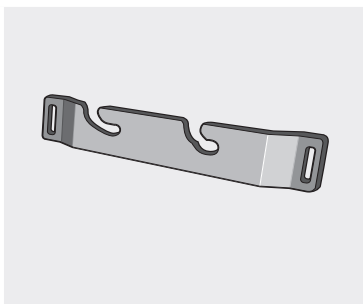

Bracket-Wall Mount



Wireless Subwoofer (PS-WWS1)



▪ The accessories may look slightly different than these.

safety information

SAFETY WARNINGS

TO REDUCE THE RISK OF ELECTRIC SHOCK, DO NOT REMOVE THE COVER(OR BACK).

NO USER-SERVICEABLE PARTS ARE INSIDE. REFER SERVICING TO QUALIFIED SERVICE PERSONNEL.



This symbol indicates “dangerous voltage” inside the product that presents a risk of electric shock or personal injury.



This symbol indicates important instructions accompanying the product.

WARNING : To reduce the risk of fire or electric shock, do not expose this appliance to rain or moisture.

CAUTION : TO PREVENT ELECTRIC SHOCK, MATCH WIDE BLADE OF PLUG TO WIDE SLOT, FULLY INSERT.

- This apparatus shall always be connected to a AC outlet with a protective grounding connection.
- To disconnect the apparatus from the mains, the plug must be pulled out from the mains socket, therefore the mains plug shall be readily operable.

CAUTION

- Apparatus shall not be exposed to dripping or splashing and no objects filled with liquids, such as vases, shall be placed on the apparatus.
- The Mains plug is used as a disconnect device and shall stay readily operable at any time.

PRECAUTIONS

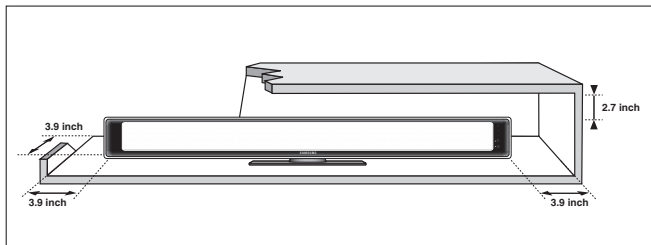

Ensure that the AC power supply in your house complies with the identification sticker located on the back of your product. Install your product horizontally, on a suitable base (furniture), with enough space around it for ventilation (3–4 inches). Make sure the ventilation slots are not covered. Do not place the unit on amplifiers or other equipment which may become hot. This unit is designed for continuous use. In order to disconnect the unit completely from the power supply, remove the main plug from the wall outlet, especially when left unused for a long period of time.

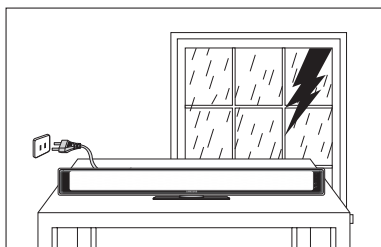

During thunderstorms, disconnect the AC main plug from the wall outlet. Voltage peaks due to lightning could damage the unit.

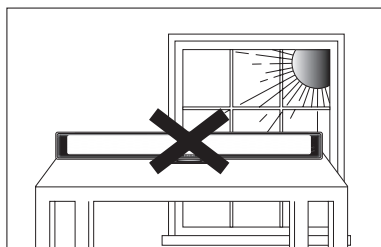

Do not expose the unit to direct sunlight or other heat sources. This could lead to overheating and malfunction of the unit.

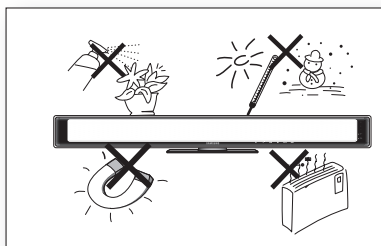

Protect the product from moisture (i.e. vases), and excess heat (e.g. fireplace) or equipment creating strong magnetic or electric fields. Disconnect the power cable from the AC supply if the unit malfunctions. Your product is not intended for industrial use. Use of this product is for personal use only.

Condensation may occur if your product or disc has been stored in cold temperatures. If transporting the unit during the winter, wait approximately 2 hours until the unit has reached room temperature before using.

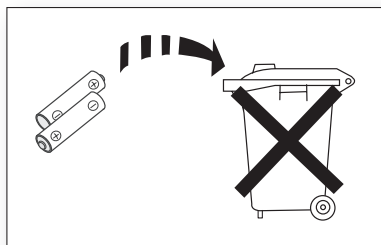

The batteries used with this product contain chemicals that are harmful to the environment. Do not dispose of batteries in the general household trash.



contents

FEATURES	2	Features
	3	What's included
SAFETY INFORMATION	4	Safety warnings
	5	Precautions
GETTING STARTED	7	Before reading the user's manual
DESCRIPTIONS	8	Front panel
	9	Rear panel
REMOTE CONTROL	10	Tour of the remote control
CONNECTIONS	12	Installing the cradle stand
	12	Installing the wall mount
	13	Connecting the wireless subwoofer
	14	Connecting the Crystal Surround Air Track
FUNCTIONS	15	Basic functions
	15	Advanced functions
TROUBLESHOOTING	17	Troubleshooting
APPENDIX	18	Specifications

BEFORE READING THE USER'S MANUAL

Make sure to check the following terms before reading the user manual.

Icons that will be used in manual

Icon	Term	Definition
	Caution	This involves a case where a function does not operate or settings may be canceled.
	Note	This involves tips or instructions on the page that help each function operate.

About the use of this user's manual

- 1) Be sure to be familiar with Safety Instructions before using this product. (See page 4)
- 2) If a problem occurs, check the Troubleshooting. (See page 17)

Copyright

©2009 Samsung Electronics Co.,Ltd.

All rights reserved; No part or whole of this user's manual may be reproduced or copied without the prior written permission of Samsung Electronics Co.,Ltd.

descriptions

FRONT PANEL

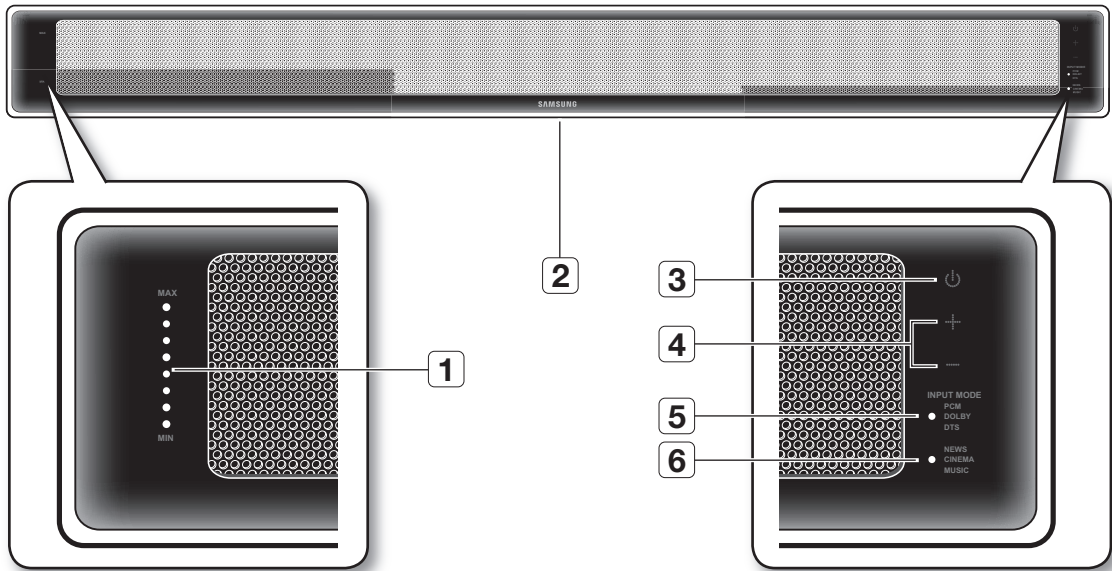

1	VOLUME LEVEL INDICATOR	Shows the current volume level. (The LED indicator lights in 8 steps, according to the volume level)
2	STANDBY LED	The standby LED lights up in standby mode. The standby LED turns off when the power of the unit turned on.
3	POWER BUTTON	Turns the Crystal Surround Air Track on and off.
4	VOLUME +/-	Controls the volume level.
5	INPUT MODE	Selects the Optical or Audio input.
6	SOUND FIELD MODE	Selects the sound field mode. (News, Cinema or Music)



- When you turn on the power of this unit, you will hear a click and there will be a 4 to 5 second delay before it can reproduce sound.

REAR PANEL

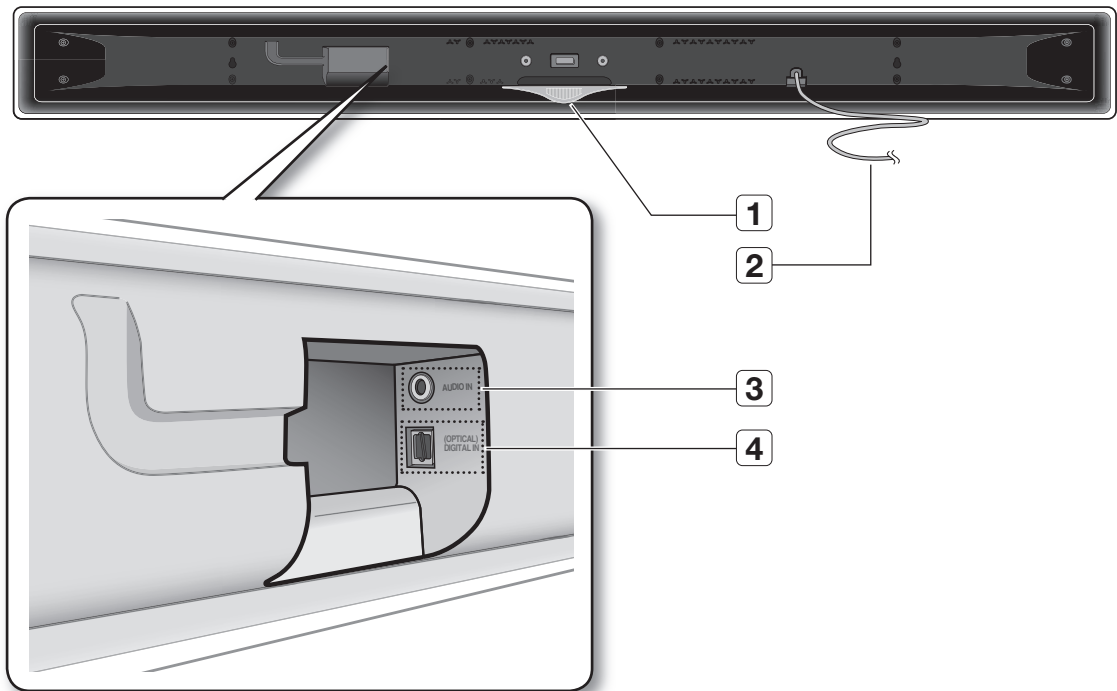

1	STANDBY LED	The standby LED lights up in standby mode. The standby LED turns off when the power of the unit is turned on.
2	POWER SUPPLY CABLE	Plug the power supply cable into the AC wall outlet.
3	AUDIO IN JACK	Connect to the analog output of an external device.
4	DIGITAL IN JACK	Connect to the digital (optical) output of an external device.

- !** When disconnecting the power cable from the wall outlet, hold the plug. Do not pull the cable.
- Do not connect this unit or other components to the main power until all connections between components are complete.

remote control

TOUR OF THE REMOTE CONTROL

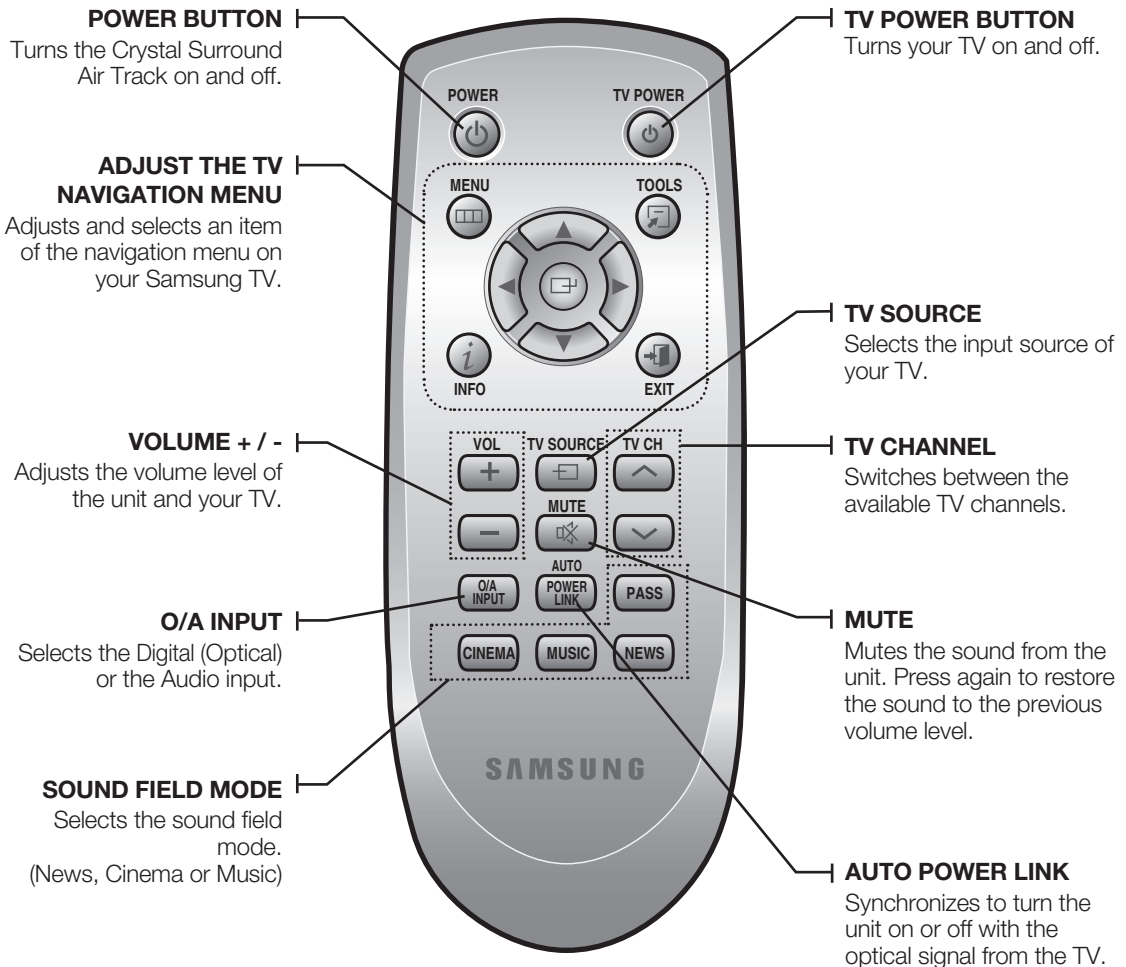

- The remote control can operate TVs made by SAMSUNG only.
- Depending on the TV you are using, you may not be able to operate your TV with this remote control. In this case, operate the TV using the TV's remote control.

Installing batteries in the Remote Control

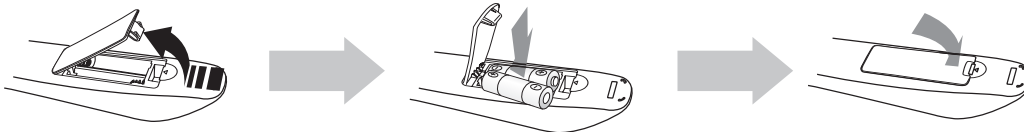

1. Lift the cover at the back of the remote control upward as shown.
2. Install two AAA size batteries. Make sure to match the “+” and “-” ends of the batteries with the diagram inside the compartment.
3. Replace the cover. Assuming typical TV usage, the batteries last for about one year.

Operation Range of the Remote Control

The remote control can be used up to approximately 23 feet (7 meters) in a straight line. It can also be operated at a horizontal angle of up to 30° from the remote control sensor.

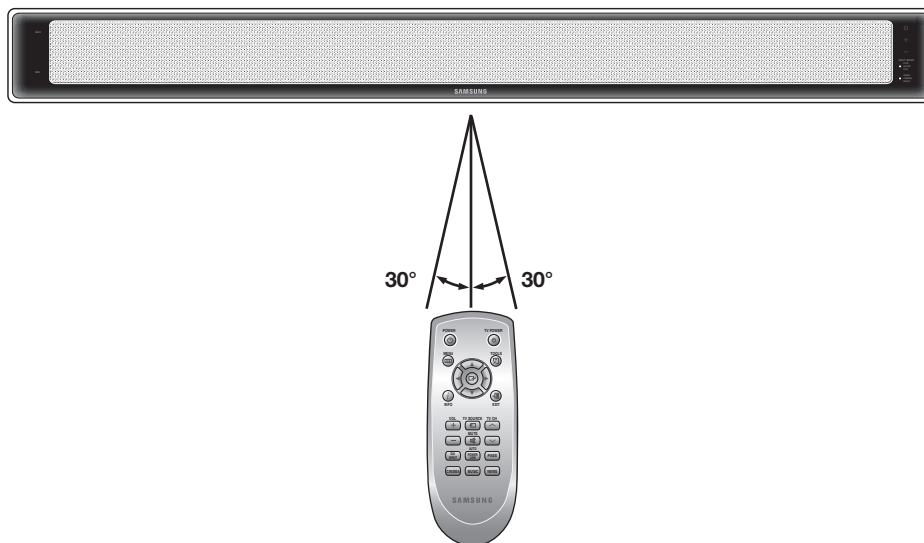

connections

INSTALLING THE CRADLE STAND

You can use the cradle stand to install this unit on a shelf. Make sure you place the unit on a flat surface.

CONNECTING

Slide the cradle stand into the speaker until you hear a click.

- Make sure the slot on the cradle stand is facing forward when connecting.

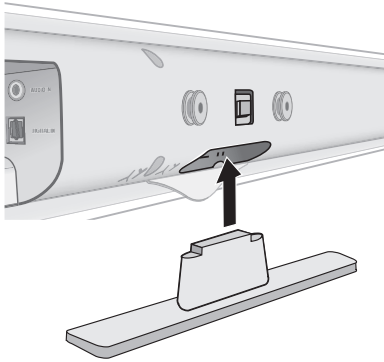

DISCONNECTING

Press the button to disconnect the cradle stand from the unit.

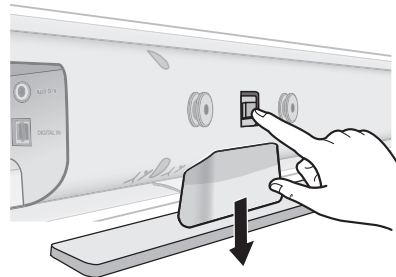

INSTALLING THE WALL MOUNT

You can use the wall mount bracket to mount this unit on the wall.

1. Place the wall mount bracket on a wall surface and then secure it with two screws (not supplied).
2. Then, fit the unit into the corresponding slots of the wall mount bracket. For secure installation, make sure the mounting studs slide firmly down into the bottom of the slots.
3. This is the completion of the suggested wall mount installation.

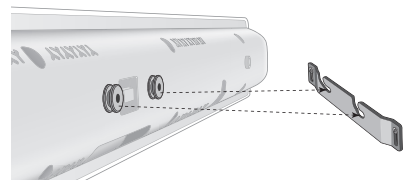
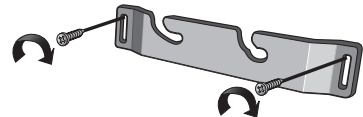

- Secure the unit firmly to the wall so that it does not fall off. If the unit falls off, it may result in an injury or damage to the product.
- When the unit is installed on a wall, please make sure that a child does not pull any of connecting cables, as it may cause it to fall.
- For the optimal performance in a wall mount installation, keep the speaker system at least 2 inches (5cm) distant from the TV.

CONNECTING THE WIRELESS SUBWOOFER (HT-WS1 ONLY)

The Subwoofer's linking ID is preset at the factory and the main unit and sub should link (connect wirelessly) automatically when turned on. If the link indicator does not light when main unit and subwoofer are turned on, please set the ID by following the process below.

1. Plug the power cords of the main unit and subwoofer into the AC power supply.
2. Press the **ID SET** button on the back of the subwoofer with a small, pointed object for 3 seconds.
 - The STANDBY indicator is turned off and the LINK indicator (blue LED) blinks quickly.

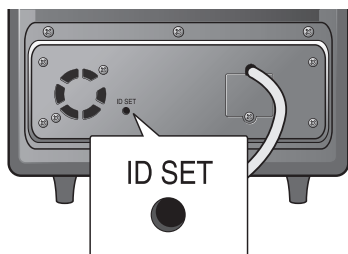

3. While main unit is powered off (STANDBY mode), press **MUTE** on the remote control for 5 seconds.
 - The volume Level Indicator on the main unit lights up, then returns to STANDBY mode.
4. Press the **POWER** button to turn on the main unit.
 - The main unit and the subwoofer are now linked (connected).
 - The Link indicator (blue LED) on the subwoofer is turned on.
 - You can enjoy better sound from the wireless subwoofer by selecting the sound field mode. (See page 16)

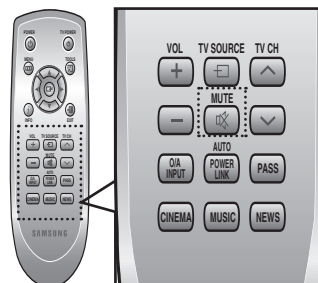

- Before moving or installing the product, be sure to turn off the power and disconnect the power cord.
- If the main unit is powered off, the wireless subwoofer will be in the standby mode and the STANDBY LED on the upper side will blink.
- If you use a device such as a microwave oven, wireless LAN Card, Bluetooth equipment, or any other device that uses the same frequency (2.4GHz) near the system, some sound interruption may be heard due to interference.
- The transmission distance of a radio wave is about 33 feet (10m), but may vary depending on your operating environment. If a steel-concrete wall or metallic wall is between the main unit and the wireless receiver module, the system may not operate at all, because the radio wave cannot penetrate metal.
- If the main unit doesn't make wireless connection, follow steps 1-4 above to retry the connection between the main unit and wireless subwoofer.



- The wireless receiving antenna is built into the wireless subwoofer. Keep the unit away from water and moisture.
- For optimal listening performance, make sure that the area around the wireless subwoofer location is clear of any obstructions.

CONNECTING THE CRYSTAL SURROUND AIR TRACK

This section explains two ways (digital and analog) of connecting the unit to the TV.

This unit is equipped with one optical digital jack and one audio analog jack for connecting a TV.

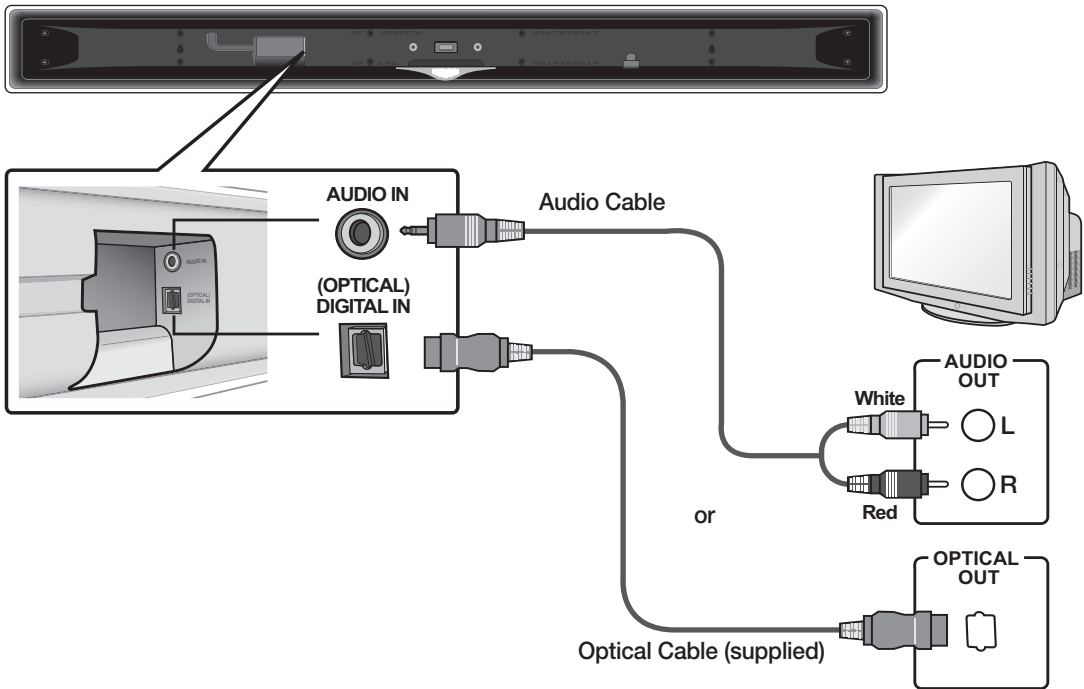

AUDIO IN

Connect AUDIO IN on the main unit to the AUDIO OUT of the TV.
Be sure to match connector colors.

OR,

DIGITAL IN (OPTICAL)

Connect the Digital Input on the main unit to the OPTICAL OUT of the TV.



- Do not connect the power cord of this product or your TV to the wall outlet until all connections between components are complete.
- Before moving or installing this product, be sure to turn off the power and disconnect the power cord.
- You can connect this unit to other external components. (such as DVD player, Set-Top Box etc.)

BASIC FUNCTIONS

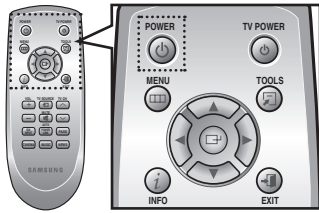

Turning the power on/off

1. Touch **POWER** (⏻) on the front panel.
OR,
Press **POWER** on the remote control to turn on the power.
 - The volume level appears in the front panel display.
2. Touch **POWER** (⏻) on the front panel.
OR,
Press **POWER** on the remote control again to turn off the power.

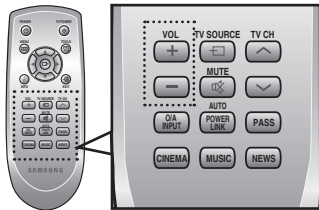

Adjusting the volume

Touch **VOLUME +/-** on the front panel.

OR,

Press **VOLUME +/-** on the remote control to increase or decrease the volume level.

- The numeric value of the volume level appears in the front panel display.



- The volume level increases or decreases when you press VOLUME +/-.
- If you want to enjoy the sound only from the Crystal Surround Air Track, select EXTERNAL AMPLIFIER in the AUDIO SETUP menu of the TV. Refer to the owner's manual supplied with your TV.

ADVANCED FUNCTIONS

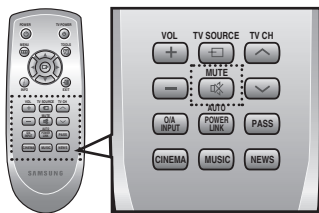

Muting the sound

This is useful when answering a doorbell or telephone call.

1. Press **MUTE** (⏻) on the remote control to mute the sound.
2. Press **MUTE** on the remote control again (or press **VOLUME +/-**) to restore the sound.



Selecting the input mode

You can select either Optical input or Audio input.

Press **O/A INPUT** on the remote control or touch **INPUT MODE** on the front panel repeatedly to select the Digital (Optical) or Audio input.

Input mode		LED color
Digital input (Optical)	PCM	Red
	DOLBY	Green
	DTS	Blue
Audio input		Off

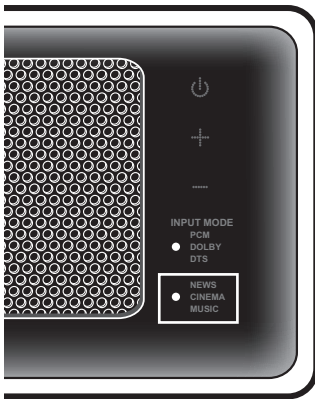

Using the sound field mode

You can select from three different sound field modes (NEWS, CINEMA and MUSIC) depending on the type of sources you want to enjoy. The color of the LED indicates sound field mode.

Sound field mode	LED color	Function
NEWS	Red	Press NEWS on the remote control when you play news sources.
CINEMA	Green	Press CINEMA on the remote control when you play movie sources.
MUSIC	Blue	Press MUSIC on the remote control when you play music sources.
PASS	Off	Press PASS on the remote control if you want to enjoy the original sound.

Using the AUTO POWER LINK function

If you turn the power of the TV on/off when the Crystal Surround Air Track is connected to your Samsung TV, the unit is also automatically turned on/off. (The unit will power off after 20 min.)

Press **AUTO POWER LINK** on the remote control of this unit.

- Auto power link function turns on and off each time you press **AUTO POWER LINK**.

AUTO POWER LINK	Standby LED
On	Standby LED will blink quickly 3 times.
Off	Standby LED will blink 1 time.



Using the TV functions

1. Press **TV POWER** on the remote control of this unit.
2. Press **TV CH** on the remote control to select the TV channel.
3. Press **VOLUME +/-** on the remote control to adjust the volume level of this unit.
4. Select one of the sound field mode buttons on the remote control to select the desired sound field mode.



- The remote control can operate TVs made by SAMSUNG only.

troubleshooting

Before requesting service, please check the following.

Symptom	Check	Remedy
The unit will not turn on.	<ul style="list-style-type: none">• Is the power cord plugged into the outlet?	<ul style="list-style-type: none">• Connect the power plug to the outlet.
A function does not work when the button is pressed.	<ul style="list-style-type: none">• Is there static electricity in the air?	<ul style="list-style-type: none">• Disconnect the power plug and connect it again.
Sound is not produced.	<ul style="list-style-type: none">• Is the unit properly connected to your TV?• Is the Mute function on?• Is the volume set to minimum?	<ul style="list-style-type: none">• Connect it correctly.• Press Mute button to cancel the function.• Adjust the volume.
Picture does not appear on a TV when the function is selected.	<ul style="list-style-type: none">• Is the TV connected properly?	<ul style="list-style-type: none">• Connect it correctly.
Remote control does not work.	<ul style="list-style-type: none">• Are the batteries drained?• Is the distance between remote control and main unit too far?	<ul style="list-style-type: none">• Replace with new batteries.• Operate at a close distance.
The sound from the left/right channels is reversed.	<ul style="list-style-type: none">• Are the left/right audio output cables from the TV connected properly?	<ul style="list-style-type: none">• Check the left/right channel and connect it/them correctly.

appendix

SPECIFICATIONS

GENERAL	Power supply		AC 120V, 60Hz
	Standby power consumption		0.9W
	Power consumption	Main unit	35W
		Subwoofer	35W
	Weight	Main unit	5.29 lbs
		Subwoofer	16.1lbs
	Dimensions (W x H x D)	Main unit	39.4 x 4.6 x 2.5 inches
		Subwoofer	11.4 x 14.6 x 11.6 inches
Operating temperature range		+41°F to +95°F	
Operating humidity range		10 % to 75 %	
AMPLIFIER	Rated output power	Main unit	80W/CH, 4Ω, THD = 10%, 1kHz
		Subwoofer	100W, 3Ω, THD = 10%, 120Hz
	Input sensitivity/Impedance		1800mV/47KΩ
	S/N ratio (analog input)		70dB
	Separation(1kHz)		60dB
FREQUENCY RESPONSE	Analog input		20Hz~20kHz(±3dB)
	Digital input/48kHz PCM		20Hz~20kHz(±3dB) ... based on TV

* S/N ratio, distortion, separation and usable sensitivity are based on measurement using AES (Audio Engineering Society) guidelines.

*: Nominal specification

- Samsung Electronics Co., Ltd reserves the right to change the specifications without notice.

- Weight and dimensions are approximate.



LIMITED WARRANTY TO ORIGINAL PURCHASER

Samsung Electronics Canada Inc.(SECA), warrants that this product is free from defective material and workmanship.

SECA further warrants that if this product fails to operate properly within the specified warranty period and the failure is due to improper workmanship or defective materials, SECA will repair or replace the product at its option.

All warranty repairs must be performed by a SECA Authorized Service Center. (The name and address of the location nearest you can be obtained by calling toll free: 1- 800- SAMSUNG)

LABOR

One year (Carry- in)

PARTS

One year

On carry-in models, transportation to and from the service center is the customer's responsibility.

The original dated sales receipt must be retained by the customer and is the only acceptable proof of purchase. It must be presented to the authorized service center at the time service is requested.

EXCLUSIONS (WHAT IS NOT COVERED)

This warranty does not cover damage due to accident, fire, flood and/ or other acts of God; misuse, incorrect line voltage, improper installation, improper or unauthorized repairs, commercial use or damage that occurs in shipping. Exterior and interior finish, lamps, glass are not covered under this warranty. Customer adjustments which are explained in the instruction manual are not covered under the terms of this warranty. This warranty will automatically be voided for any unit found with a missing or altered serial number. This warranty is valid only on products purchased and used in Canada.

**HEADQUARTERS
SAMSUNG ELECTRONICS CANADA INC.,
CUSTOMER SERVICE
55 STANDISH COURT MISSISSAUGA, ONTARIO L5R 4B2 CANADA
FABRIQUE EN CORÉE
1-800-SAMSUNG (1-800-7267864)
WWW.SAMSUNG.COM/CA**

Contact SAMSUNG WORLD WIDE

If you have any questions or comments relating to Samsung products, please contact the SAMSUNG customer care center.

Region	Country	Customer Care Center ☎	Web Site
North America	CANADA	1-800-SAMSUNG(726-7864)	www.samsung.com/ca
	MEXICO	01-800-SAMSUNG(726-7864)	www.samsung.com/mx
	U.S.A	1-800-SAMSUNG(726-7864)	www.samsung.com/us
Latin America	ARGENTINE	0800-333-3733	www.samsung.com/ar
	BRAZIL	0800-124-421, 4004-0000	www.samsung.com/br
	CHILE	800-SAMSUNG(726-7864)	www.samsung.com/cl
	NICARAGUA	00-1800-5077267	www.samsung.com/latin
	HONDURAS	800-7919267	www.samsung.com/latin
	COSTA RICA	0-800-507-7267	www.samsung.com/latin
	ECUADOR	1-800-10-7267	www.samsung.com/latin
	EL SALVADOR	800-6225	www.samsung.com/latin
	GUATEMALA	1-800-299-0013	www.samsung.com/latin
	JAMAICA	1-800-234-7267	www.samsung.com/latin
	PANAMA	800-7267	www.samsung.com/latin
	PUERTO RICO	1-800-682-3180	www.samsung.com/latin
	REP. DOMINICA	1-800-751-2676	www.samsung.com/latin
	TRINIDAD & TOBAGO	1-800-SAMSUNG(726-7864)	www.samsung.com/latin
VENEZUELA	0-800-100-5303	www.samsung.com/latin	
COLOMBIA	01-8000112112	www.samsung.com.co	
Europe	BELGIUM	02 201 2418	www.samsung.com/be (Dutch) www.samsung.com/be_fr (French)
	CZECH REPUBLIC	800-SAMSUNG(800-726786)	www.samsung.com/cz
	DENMARK	8-SAMSUNG(7267864)	www.samsung.com/dk
	FINLAND	30-6227 515	www.samsung.com/fi
	FRANCE	01 4863 0000	www.samsung.com/fr
	GERMANY	01805 - SAMSUNG(726-7864 € 0,14/Min)	www.samsung.de
	HUNGARY	06-80-SAMSUNG(726-7864)	www.samsung.com/hu
	ITALIA	800-SAMSUNG(726-7864)	www.samsung.com/it
	LUXEMBURG	02 261 03 710	www.samsung.com/lu
	NETHERLANDS	0900-SAMSUNG (0900-7267864) (€ 0,10/Min)	www.samsung.com/nl
	NORWAY	3-SAMSUNG(7267864)	www.samsung.com/no
	POLAND	0 801 1SAMSUNG(172678), 022-607-93-33	www.samsung.com/pl
	PORTUGAL	80820-SAMSUNG(726-7864)	www.samsung.com/pt
	SLOVAKIA	0800-SAMSUNG(726-7864)	www.samsung.com/sk
	SPAIN	902-1-SAMSUNG (902 172 678)	www.samsung.com/es
	SWEDEN	075-SAMSUNG(726 78 64)	www.samsung.com/se
	U.K	0845 SAMSUNG (7267864)	www.samsung.com/uk
	EIRE	0818 717 100	www.samsung.com/ie
	AUSTRIA	0810-SAMSUNG(7267864, € 0,07/min)	www.samsung.com/at
	SWITZERLAND	0848-SAMSUNG(7267864, CHF 0.08/min)	www.samsung.com/ch
CIS	RUSSIA	8-800-555-55-55	www.samsung.ru
	KAZAHSTAN	8-10-800-500-55-500	www.samsung.com/kz_ru
	UZBEKISTAN	8-10-800-500-55-500	www.samsung.com/kz_ru
	KYRGYZSTAN	00-800-500-55-500	
	TADJIKISTAN	8-10-800-500-55-500	
	UKRAINE	8-800-502-0000	www.samsung.ua
	LITHUANIA	8-800-77777	www.samsung.com/lt
	LATVIA	8000-7267	www.samsung.com/lv
	ESTONIA	800-7267	www.samsung.com/ee
	Asia Pacific	AUSTRALIA	1300 362 603
NEW ZEALAND		0800 SAMSUNG (0800 726 786)	www.samsung.com/nz
CHINA		800-810-5858, 400-810-5858, 010-6475 1880	www.samsung.com/cn
HONG KONG		3698-4698	www.samsung.com/hk
INDIA		3030 8282, 1800 110011, 1-800-3000-8282	www.samsung.com/in
INDONESIA		0800-112-8888	www.samsung.com/id
JAPAN		0120-327-527	www.samsung.com/jp
MALAYSIA		1800-88-9999	www.samsung.com/my
PHILIPPINES		1-800-10-SAMSUNG(726-7864) 1-800-3-SAMSUNG(726-7864), 02-5805777	www.samsung.com/ph
SINGAPORE		1800-SAMSUNG(726-7864)	www.samsung.com/sg
THAILAND		1800-29-3232, 02-689-3232	www.samsung.com/th
TAIWAN		0800-329-999	www.samsung.com/tw
VIETNAM		1 800 588 889	www.samsung.com/vn
Middle East & Africa	TURKEY	444 77 11	www.samsung.com/tr
	SOUTH AFRICA	0860-SAMSUNG(726-7864)	www.samsung.com/za
	U.A.E	800-SAMSUNG (726-7864), 8000-4726	www.samsung.com/ae

